

NOZZLE ASSEMBLY JIG  
FUJI, CP3

(LARGE)

(SMALL)

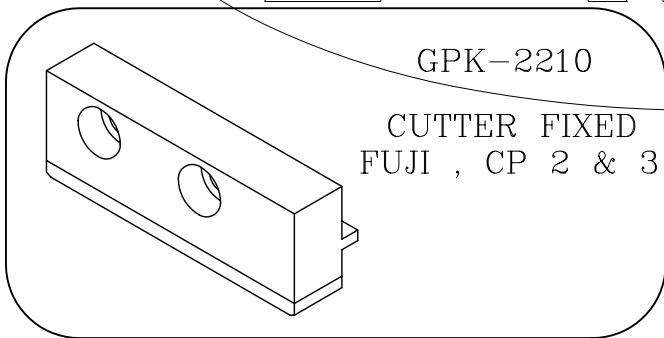

GPK-2210

CUTTER FIXED  
FUJI , CP 2 & 3

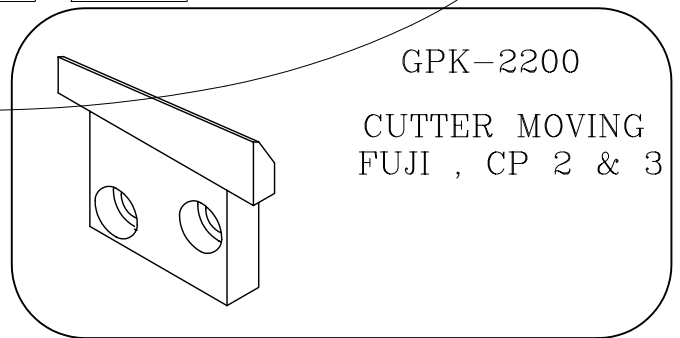

GPK-2200

CUTTER MOVING  
FUJI , CP 2 & 3

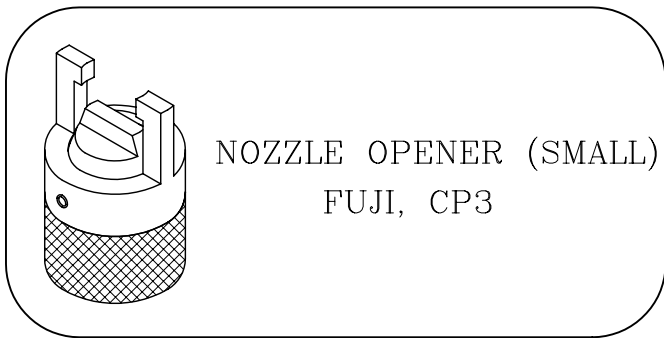

NOZZLE OPENER (SMALL)  
FUJI, CP3

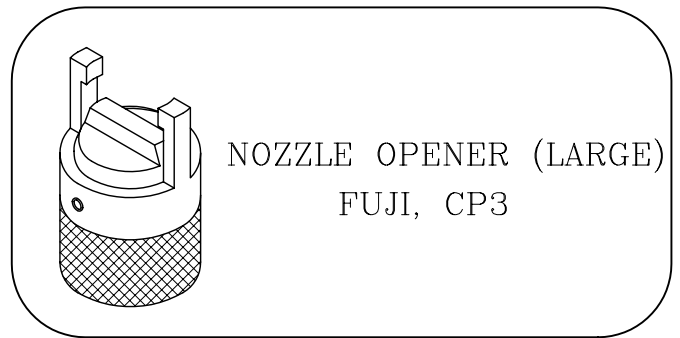

NOZZLE OPENER (LARGE)  
FUJI, CP3

# FUJI CP3 PICK UP NOZZLE

AGPH-9560

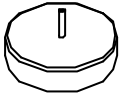

PICK-UP NOZZLE  $\phi 0.7-S$   
FUJI, CP3

AGPH-9410

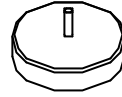

PICK-UP NOZZLE  $\phi 1.0-S$   
FUJI, CP3

AGPH-9130

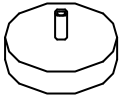

PICK-UP NOZZLE  $\phi 1.3-S$   
FUJI, CP3

AGPH-9050

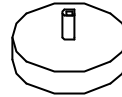

PICK-UP NOZZLE  $\phi 1.3-S$   
(MELF)  
FUJI, CP3

AGPH-9470

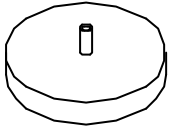

PICK-UP NOZZLE  $\phi 1.3-L$   
FUJI, CP3

AGPH-9460

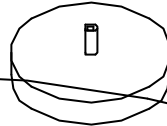

PICK-UP NOZZLE  $\phi 1.3-L$   
(MELF)  
FUJI, CP3

AGPH-9060

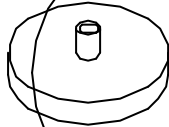

PICK-UP NOZZLE  $\phi 2.5-L$   
FUJI, CP3

AGPH-9430



PICK-UP NOZZLE  $\phi 3.4-L$   
FUJI, CP3

AGPH-9570

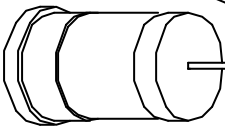

DARK POINT  $\phi 0.7-S$   
FUJI, CP3

AGPH-9550

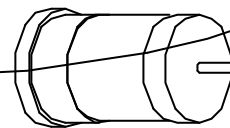

DARK POINT  $\phi 1.0-S$   
FUJI, CP3

AGPH-9190

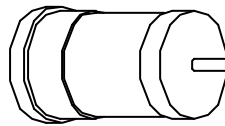

DARK POINT  $\phi 1.3-S$   
FUJI, CP3

AGPH-9480



DARK POINT  $\phi 1.3-L$   
FUJI, CP3

AGPH-9200

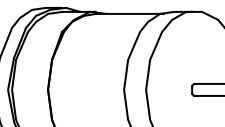

DARK POINT  $\phi 2.5-L$   
FUJI, CP3

AGPH-9440

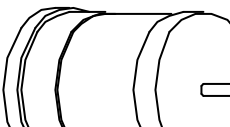

DARK POINT  $\phi 3.4-L$   
FUJI, CP3

# FUJI, CP4

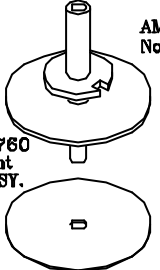

AMPH-8260  
Nozzle ASSY.

AMPH-8760  
Fluorescent  
Nozzle ASSY.

LPH-3010  
Fluorescent  
Seal.

PICK-UP NOZZLE  $\phi 2.5-L$   
FUJI, CP4



LPH-5010  
Fluorescent Seal.

AMPH-8710  
Fluorescent  
Nozzle ASSY.

AMPH-8210  
Nozzle ASSY.

PICK-UP NOZZLE  $\phi 0.7-S$   
FUJI, CP4

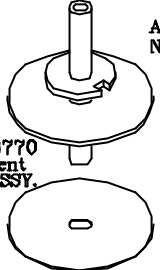

AMPH-8270  
Nozzle ASSY.

AMPH-8770  
Fluorescent  
Nozzle ASSY.

LPH-3020  
Fluorescent  
Seal.

PICK-UP NOZZLE  $\phi 3.7-L$   
FUJI, CP4

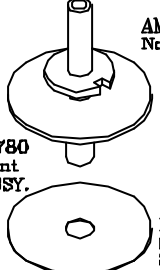

AMPH-8280  
Nozzle ASSY.

AMPH-8780  
Fluorescent  
Nozzle ASSY.

LPH-3030  
Fluorescent  
Seal.

PICK-UP NOZZLE  $\phi 5.0-L$   
FUJI, CP4

**\*ORDERS FOR FLUORESCENT SEAL ONLY\***  
MINIMUM QTY IS 100 EACH.

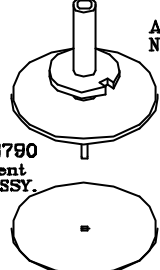

AMPH-8290  
Nozzle ASSY.

AMPH-8790  
Fluorescent  
Nozzle ASSY.

LPH-3040  
Fluorescent  
Seal.

PICK-UP NOZZLE  $\phi 1.3-L$   
FUJI, CP4

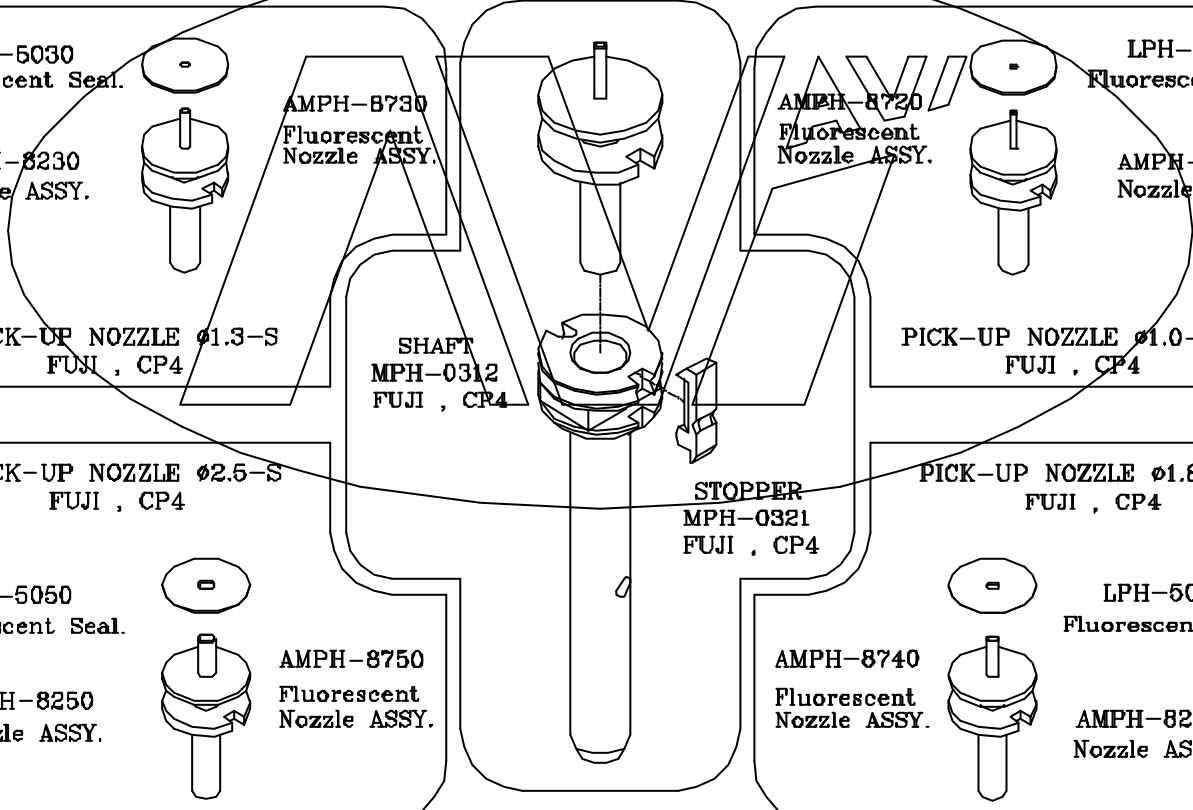

LPH-5030  
Fluorescent Seal.

AMPH-8230  
Nozzle ASSY.

PICK-UP NOZZLE  $\phi 1.3-S$   
FUJI, CP4

AMPH-8730  
Fluorescent  
Nozzle ASSY.

SHAFT  
MPH-0312  
FUJI, CP4

AMPH-8720  
Fluorescent  
Nozzle ASSY.

LPH-5020  
Fluorescent Seal.

AMPH-8220  
Nozzle ASSY.

PICK-UP NOZZLE  $\phi 1.0-S$   
FUJI, CP4

PICK-UP NOZZLE  $\phi 2.5-S$   
FUJI, CP4

STOPPER  
MPH-0321  
FUJI, CP4

PICK-UP NOZZLE  $\phi 1.8-S$   
FUJI, CP4

LPH-5050  
Fluorescent Seal.

AMPH-8250  
Nozzle ASSY.

AMPH-8750  
Fluorescent  
Nozzle ASSY.

LPH-5040  
Fluorescent Seal.

AMPH-8740  
Fluorescent  
Nozzle ASSY.

AMPH-8240  
Nozzle ASSY.

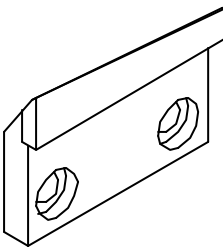

MPK-0060

CUTTER MOVING  
FUJI, CP4

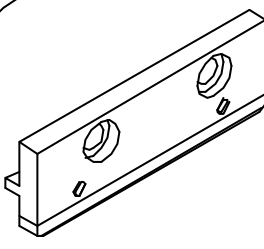

MPK-0083

CUTTER FIXED  
FUJI, CP4

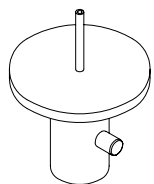

AWPH-9510

PICK-UP NOZZLE  $\phi 0.7-12$   
FUJI, CP6

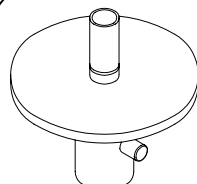

AWPH-9560

PICK-UP NOZZLE  $\phi 2.5-16$   
FUJI, CP6

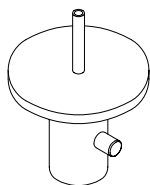

AWPH-9520

PICK-UP NOZZLE  $\phi 1.0-12$   
FUJI, CP6

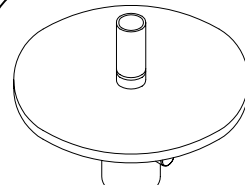

AWPH-9580

PICK-UP NOZZLE  $\phi 2.5-20$   
FUJI, CP6

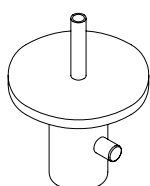

AWPH-9530

PICK-UP NOZZLE  $\phi 1.3-12$   
FUJI, CP6

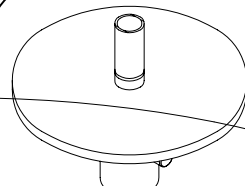

AWPH-9591  
(MELF)

PICK-UP NOZZLE  $\phi 2.5-20$   
FUJI, CP6

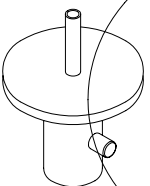

AWPH-9541  
(MELF)

PICK-UP NOZZLE  $\phi 1.3-12$   
FUJI, CP6

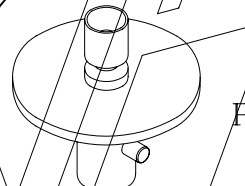

AWPH-9570

PICK-UP NOZZLE  $\phi 3.7-16$   
FUJI, CP6

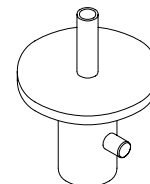

AWPH-9550

PICK-UP NOZZLE  $\phi 1.8-12$   
FUJI, CP6

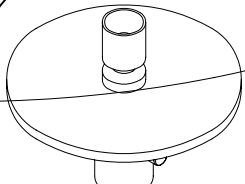

AWPH-9600

PICK-UP NOZZLE  $\phi 3.7-20$   
FUJI, CP6

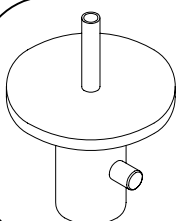

AWPH-9520

PICK-UP NOZZLE  $\phi 0.7-8$   
FUJI, CP7

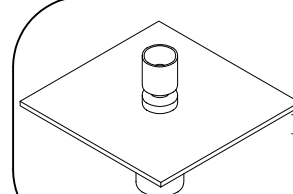

AWPH-9610

PICK-UP NOZZLE  $\phi 5-20$   
FUJI, CP6

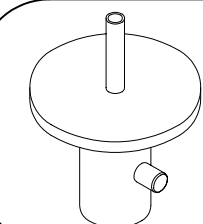

AWPH-9530

PICK-UP NOZZLE  $\phi 1.0-8$   
FUJI, CP7

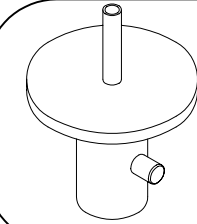

AWPH-9540

PICK-UP NOZZLE  $\phi 1.3-8$   
FUJI, CP7

# FUJI CP6 PICK UP NOZZLE

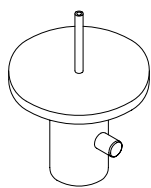

AWPH-9510

PICK-UP NOZZLE  $\phi 0.7-12$   
FUJI, CP6

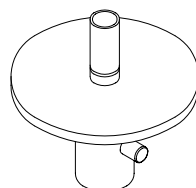

AWPH-9560

PICK-UP NOZZLE  $\phi 2.5-16$   
FUJI, CP6

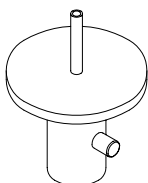

AWPH-9520

PICK-UP NOZZLE  $\phi 1.0-12$   
FUJI, CP6

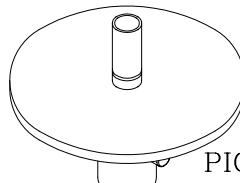

AWPH-9580

PICK-UP NOZZLE  $\phi 2.5-20$   
FUJI, CP6

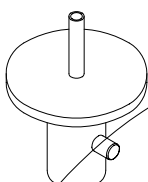

AWPH-9530

PICK-UP NOZZLE  $\phi 1.3-12$   
FUJI, CP6

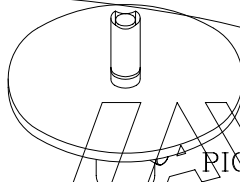

AWPH-9591  
(MELF)

PICK-UP NOZZLE  $\phi 2.5-20$   
FUJI, CP6

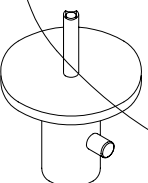

AWPH-9541  
(MELF)

PICK-UP NOZZLE  $\phi 1.3-12$   
FUJI, CP6

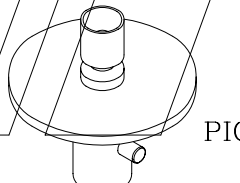

AWPH-9570

PICK-UP NOZZLE  $\phi 3.7-16$   
FUJI, CP6

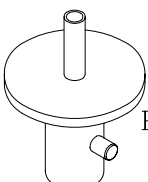

AWPH-9550

PICK-UP NOZZLE  $\phi 1.8-12$   
FUJI, CP6

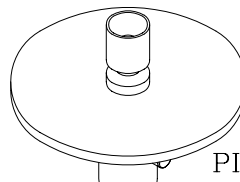

AWPH-9600

PICK-UP NOZZLE  $\phi 3.7-20$   
FUJI, CP6

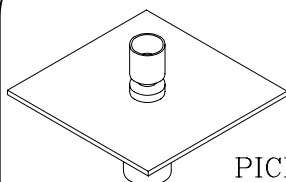

AWPH-9610

PICK-UP NOZZLE  $\phi 5-20$   
FUJI, CP6

# FUJI CP7 PICK UP NOZZLE

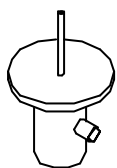

ADCPH-9510

PICK-UP NOZZLE  $\phi 0.4-8$   
FUJI, CP7

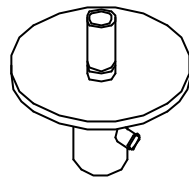

ADCPH-9560

PICK-UP NOZZLE  $\phi 2.5-16$   
FUJI, CP7

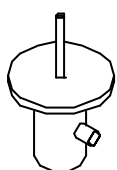

ADCPH-9520

PICK-UP NOZZLE  $\phi 0.7-8$   
FUJI, CP7

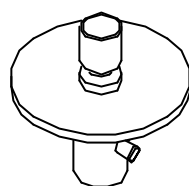

ADCPH-9570

PICK-UP NOZZLE  $\phi 3.7-16$   
FUJI, CP7

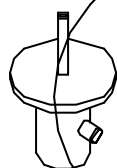

ADCPH-9530

PICK-UP NOZZLE  $\phi 1.0-8$   
FUJI, CP7

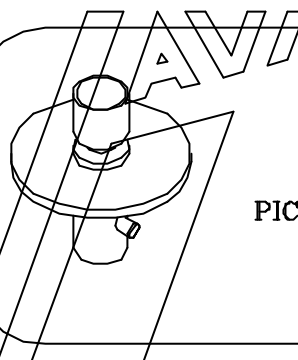

ADCPH-9580

PICK-UP NOZZLE  $\phi 5.0-16$   
FUJI, CP7

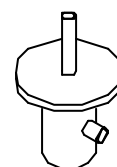

ADCPH-9540

PICK-UP NOZZLE  $\phi 1.3-8$   
FUJI, CP7

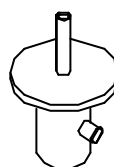

ADCPH-9700  
(MELF)

PICK-UP NOZZLE  $\phi 1.3-8$   
FUJI, CP7

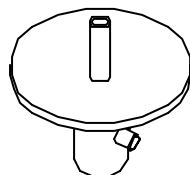

ADCPH-9550

PICK-UP NOZZLE  $\phi 1.8-16$   
FUJI, CP7

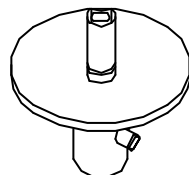

ADCPH-9710  
(MELF)

PICK-UP NOZZLE  $\phi 2.5-16$   
FUJI, CP7